

SELEC CH403C
Operating Instructions



36 x 72

PARAMETER	SPECIFICATIONS
Display	3 digit, 7 Segment display
Key	4 (Capacitive Touch)
Accuracy	±1°
Control action	ON/OFF (with hysteresis programmable)
Display offset	-19.9 to 19.9
Restart time delay	Programmable from 0 to 19.9 minutes
Defrost time	Programmable from 0 to 99 minutes
Defrost frequency	Programmable from 0 to 99 (Hr/Min/Sec)
Relay action	a) Heat mode b) Cool mode
Sensor Break	'br' indicated on display
Protection	IP65 Frontal

OUTPUT	
CH403C-1-NTC V2 :	
1) Main output	: SPDT, 10A@250VAC/30V DC
2) Alarm output	: SSR drive
CH403C-2-NTC :	
1) Main output	: SPST, 20A@230VAC/30V DC
CH403C-3-NTC :	
1) Main output	: SPDT, 10A@250VAC/30V DC
2) Alarm output	: SPST, 5A@250VAC/30V DC

Power supply	CH403C-1-NTC V2 : 230VAC@50/60Hz CH403C-2-NTC : 230VAC@50/60Hz CH403C-3-NTC : 230VAC@50/60Hz
Temperature	Operating : 0 to 60°C Storage : -20 to 75°C
Humidity	95% RH (Non-condensing)
Weight	CH403C-1-NTC V2 : 150 g CH403C-2-NTC : 150 g CH403C-3-NTC : 150 g
Power consumption	CH403C-1-NTC V2 : 3VA maximum CH403C-2-NTC : 3VA maximum CH403C-3-NTC : 3VA maximum

Alarm Indications
 a) High Alarm : Display alternates between 'HA/PV'
 b) Low Alarm : Display alternates between 'LA/PV'
 c) Door open Alarm : Display alternates between 'dO/PV'

SAFETY PRECAUTIONS

All safety related codifications, symbols and instructions that appear in this operating manual or on the equipment must be strictly followed to ensure the safety of the operating personnel as well as the instrument.
 If the equipment is not handled in a manner specified by the manufacturer it might impair the protection provided by the equipment.

CAUTION : Read complete instructions prior to installation and operation of the unit.

WARNING : Risk of electric shock.

WIRING GUIDELINES

- WARNING :**
- To prevent the risk of electric shock power supply to the equipment must be kept OFF while doing the wiring arrangement. Use lugged terminals to meet M3 screws.
 - Wiring shall be done strictly according to the terminal Layout with shortest connections. Confirm that all connections are correct.
 - To eliminate electromagnetic interference use of short wire with adequate ratings and twists of the same in equal size shall be made.
 - Cable used for connection to power source, must have a cross section of 1mm² or greater. These wires shall have insulation capacity made of at least 1.5KV.

INSTALLATION GUIDELINES

- CAUTION :**
- This equipment, being built-in-type, normally becomes a part of main control panel and in such case the terminals do not remain accessible to the end user after Installation and internal wiring.
 - Conductors must not come in contact with the internal Circuitry of the equipment or else it may lead to a safety hazard that may in turn endanger life or cause electrical shock to the operator.
 - Circuit breaker or mains switch must be installed between power source and supply terminals to facilitate power 'ON' or 'OFF' function. However this switch or breaker must be installed in a convenient position normally accessible to the operator.

CAUTION :

- The equipment shall not be installed in environmental conditions other than those mentioned in this manual.
- Fuse Protection :
The equipment does not have a built-in-type fuse. Installation of external fuse of rating 275VAC/1Amp for electrical circuitry is highly recommended.
- Thermal dissipation of equipment is met through ventilation holes provided on chassis of equipment. Such ventilation holes shall not be obstructed else it can lead to a safety hazard.
- The output terminals shall be strictly loaded to the manufacturer specified values/range.

MAINTENANCE

- The equipment should be cleaned regularly to avoid blockage of ventilating parts.
- Please clean the equipment with a clean soft cloth. Do not use Isopropyl alcohol or any other cleaning agent

MECHANICAL INSTALLATION

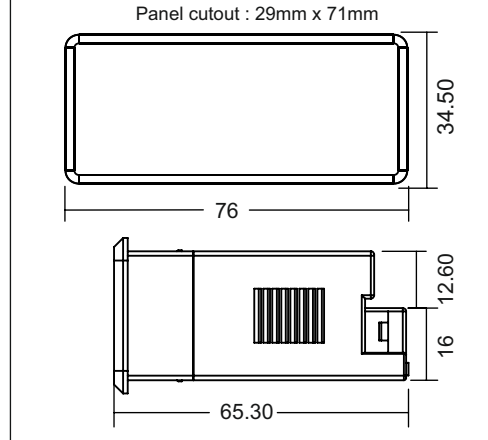

TYPICAL CONNECTIONS FOR LOADS

1) For load current less than 0.5A

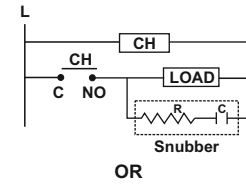

2) For bigger loads use interposing relay/contactor

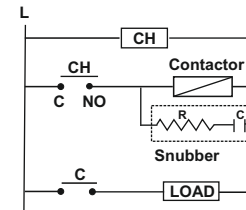

NOTE : Use snubber as shown above to increase life of internal relay of temperature controller.

TERMINAL CONNECTIONS

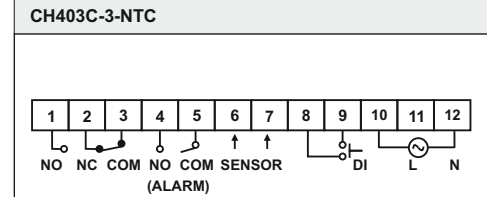
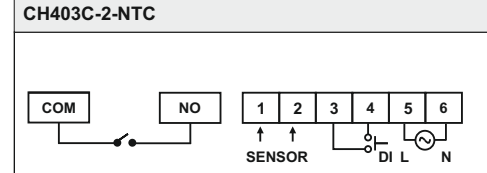
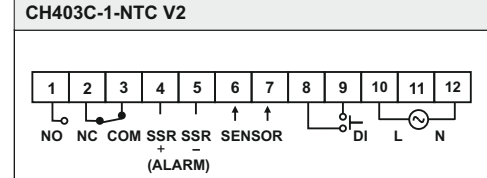

FRONT PANEL DESCRIPTION

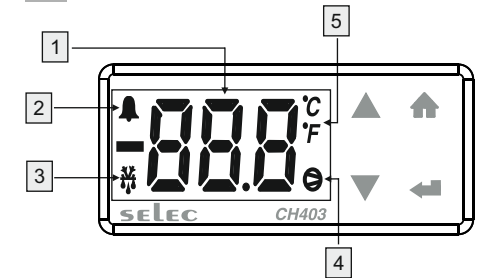

1) Process-value/ Parameter display/ Set point display	1) Display process value and its error condition 2) Display parameter symbols in configuration menu for 1 sec and then the parameter values 3) Displays set point value
2) Alarm	Indicates Alarm condition
3) Defrost	Indicates defrost in progress
4) Main output	Indicates main output ON
5) Temperature Unit	Indication for selected Temperature Unit (°C/°F)

USER GUIDE

1) ON/OFF control action (for cooler) :

The relay is 'OFF' up to the set temperature and 'ON' above the set temperature. As the temperature of the system drops, the relay is switched 'OFF' at a temperature slightly lower than the set point.

Hysteresis : The difference between the temperature at which relay switches 'ON' and at which relay switches 'OFF' is the hysteresis or dead band.

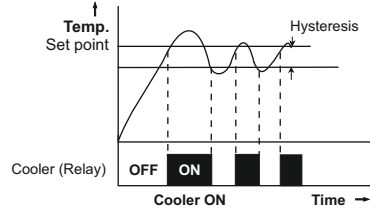

2. Display offset adjustment :

This function is used to adjust the display value in cases where it is necessary for display value to agree with another recorder or indicator, or when the sensor cannot be mounted in correct location.

3. Defrost mode :

The unit has two modes of defrost - Auto and Manual. The Auto mode can be set by programming required defrost frequency between 0 and 99 (Hr / Min / Sec). The defrost frequency excludes the defrost time. To enable Manual defrost press key ∇ continuously for 3 sec. Defrost is valid only for cool mode. During defrost relay remains OFF for a period = Programmed defrost time. Defrost once enabled can be disabled only at power ON. Defrost is disabled if Defrost frequency = 0 or Defrost time = 0.

4. Restart time delay :

This parameter is used to protect the compressor from restarting in a short period of time and can be set between 0 to 99.9 minutes.

Example : If this parameter is set at 2 mins, the relay will cut off at the set temperature, but will not restart for a minimum of 2 mins, even if the differential is achieved earlier.

5. Alarm acknowledgment :

To acknowledge the alarm, press \blacktriangle key.

6. Sensor Break :

- When set as 0, main relay is OFF during sensor break.
- When set as 1, main Relay is OFF for 10 min & On for 4 min (OFF First) during sensor break.

7. Lock Parameter :

- When set as 0, Configuration parameters & setpoint are editable
- When set as 1, Configuration parameters & setpoint are read only.

8. Alarm Indicator :

- When FN is set as AL, Alarm function is enabled. HA alarm is generated when $PV \geq HA$, display toggles every 1 sec between PV & HA Value. LA alarm is generated when $PV \leq LA$, display toggles every 1 sec between PV value & LA.

9. Resolution :

- When set as 0.1, PV ranges from $-40.0 > PV > 90.0$
- When set as 1 PV ranges from -40 to 90

10. Set point High Limit :

This function providing higher set point which can be set.

11. Set Point Low Limit :

This function providing lower set point which can be set.

CONFIGURATION INSTRUCTIONS

KEY FUNCTIONS	ONLINE	CONFIGURATION MENU	SET POINT
\leftarrow	<ul style="list-style-type: none"> ➤ Press once to view SP ($^{\circ}C/^{\circ}F$ blinking) ➤ Press for 3 sec to edit SP (Setpoint value blinking) 	<ul style="list-style-type: none"> ➤ Press once to start editing current parameter value. (Parameter value blinking) ➤ After editing, press again to store current parameter value. ($^{\circ}C/^{\circ}F$ blinking) 	<ul style="list-style-type: none"> ➤ Press once to exit Setpoint view / edit mode.
$\blacktriangle + \blacktriangledown$	<ul style="list-style-type: none"> ➤ Press for 3 sec to enter configuration menu. 		
\blacktriangledown	<ul style="list-style-type: none"> ➤ Press for 3 sec to enable Manual Defrost. 	<ul style="list-style-type: none"> ➤ To view previous parameter OR Decrement parameter value. 	<ul style="list-style-type: none"> ➤ Decrements setpoint.
\blacktriangle	<ul style="list-style-type: none"> ➤ Press once to acknowledge Alarm. 	<ul style="list-style-type: none"> ➤ To view next parameter OR Increment parameter value. 	<ul style="list-style-type: none"> ➤ Increment setpoint.
\uparrow		<ul style="list-style-type: none"> ➤ Press for 3 sec to exit configuration menu. 	<ul style="list-style-type: none"> ➤ Press 3 Sec to exit Setpoint view / Edit mode.

OPERATIONAL MENU

Display (For 1sec)	Description	Default Value	Range	Condition
P1	Control mode	CL	CL /HT	NA
P2	High alarm	100	SP to 100°	NA
P3	Low alarm	-50	-50 to SP°	NA
SH	Set Point High Limit	90	SP to 90°	NA
SL	Set Point Low Limit	-40	-40° to SP	NA
P4	Hysteresis	0.5	0.1° to 9.9°	NA
P5	Display offset	0.0	-19.9° to 19.9°	NA
P6	Restart time delay	3.0	0 to 99.9 min	NA
P7	Defrost time	0	0 to 99 min	NA
P8	Defrost Frequency	1	0 to 99 min	Defrost time>0
P9	Defrost Frequency unit	H	H / M / S	Defrost time>0
PU	Display Unit	$^{\circ}C$	$^{\circ}C / ^{\circ}F$	NA
LP	Lock parameter	0	0 / 1	NA
RS	Resolution	0.1	0.1 / 1	NA
FN	Alarm Indicator	AL	OF / AL / TM	NA
T1	Power ON Reset	YES	Yes / No	Visible only when FN=TM Applicable only for CH403C-3-NTC
T2	ON time unit	M	H / M / S	
T3	OFF time unit	M	H / M / S	
T4	ON time Resolution	1	1 or 0.1	
T5	OFF time Resolution	1	1 or 0.1	
T6	ON time	10	1 to 199	
T7	OFF time	10	1 to 199	
T8	OFF First / ON First	0	0 or 1	
T9	S.BRK - Cyclic OFF / Cyclic Continue	0	0 or 1	
E1	Sensor break alarm	0	0/1	NA
E2	Door open alarm delay	5	5 to 99s	NA
E3	Door open mode	0	0/1	NA
E5	Reset all (Set to factory default)	0	0/1	NA

MODE OF OPERATION - CYCLIC

Cyclic ON first, Cyclic OFF first modes :

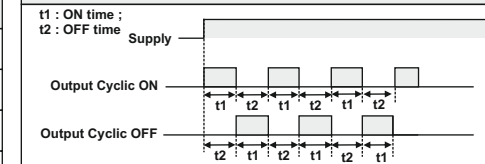

- The Cyclic Timer affects the Alarm Relay Output.

(Specifications are subject to change, since development is a continuous process.)

Selec Controls Pvt. Ltd., India

Factory Address :
EL-27/1, Electronic Zone, TTC Industrial Area, MIDC, Mahape,
Navi Mumbai - 400 710, INDIA.
Tel. No. : +91-22-41 418 452/468 | Fax No. : +91-22-28471733
Toll free : 1800 227 353 (BSNL/MTNL Subscribers only)
Website : www.selec.com | Email : sales@selec.com